

ARISTOCRAT SERIES

STEEL CARRIAGE GARAGE DOORS

ELEGANCE, AND PERFORMANCE



SAFE-WAY
GARAGE DOORS

Make a Statement.





The Aristocrat Series adds prestige to the most humble of homes. Combining the power of steel, the elegance of a carriage-style door, delivers strength, durability and outstanding performance for many years. A vast variety of models and styles ensures a perfect fit for any home or application.

The Presidential models, notated by the letter "P" offer a 3 layer steel construction with a polystyrene core. Designed for a great insulation offering at 10.25R at a reasonable price.

The Monarch models notated by the letter "M" boasts of a 3 layer steel construction with a polyurethane core and a 17.68R insulation factor. Combined with a thermal section break, these superior features provide maximum sound deadening properties and keeps the heat out in the summer and cold in the winter.

16'–20' Double Doors

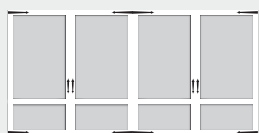

P1A/M1A

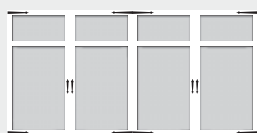

P2A/M2A

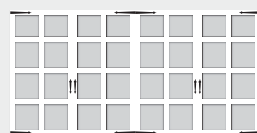

P3A/M3A

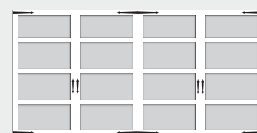

P4A/M4A

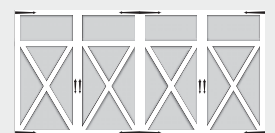

P5A/M5A



P1B/M1B*

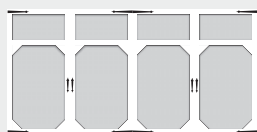

P2B/M2B

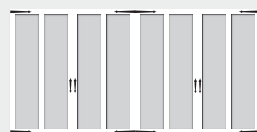

P3B/M3B*

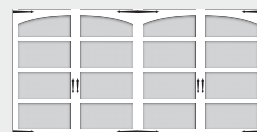

P4B/M4B*

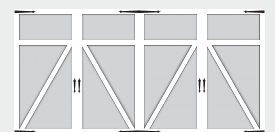

P5B/M5B

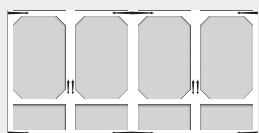

P1C/M1C*

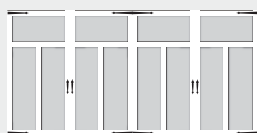

P2C/M2C

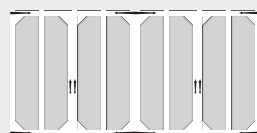

P3C/M3C*

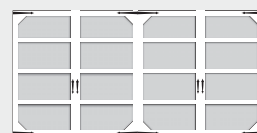

P4C/M4C

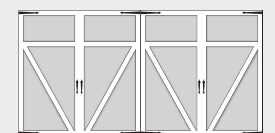

P5C/M5C

Optional Hardware Placement For
16'–20' Doors

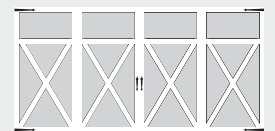

Window Options



W1



W2



W3



W4



W5

*No Window Options Available

Hardware shown may not be included; please see your local dealer for details.

Door & Window Selections



Sizes: 8', 9' & 10'

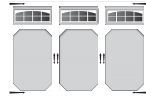

Sizes: 12' & 14'



Size: 16'-20'

Washington P1 Series

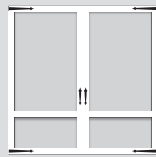

P1AS/M1AS



P1AW1/M1AW1



P1AW2/M1AW2



P1AW3/M1AW3

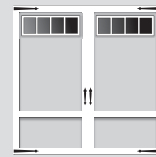

P1AW4/M1AW4



P1AW5/M1AW5

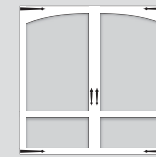

P1BS*

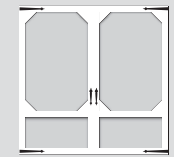

P1CS*

Jackson P2 Series



P2AS/M2AS



P2AW1/M2AW1



P2AW2/M2AW2



P2AW3/M2AW3

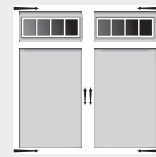

P2AW4/M2AW4

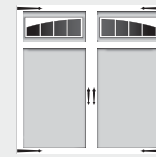

P2AW5/M2AW5

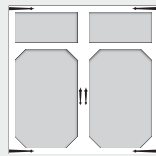

P2BS/M2BS

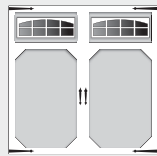

P2BW1/M2BW1

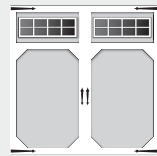

P2BW2/M2BW2

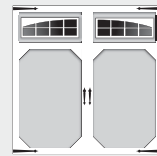

P2BW3/M2BW3

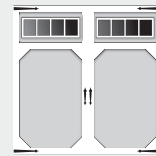

P2BW4/M2BW4

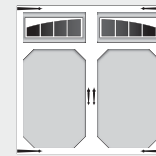

P2BW5/M2BW5

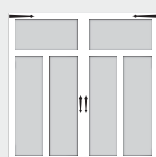

P2CS/M2CS



P2CW1/M2CW1



P2CW2/M2CW2



P2CW3/M2CW3

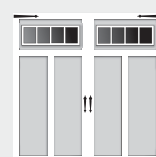

P2CW4/M2CW4

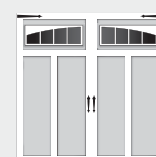

P2CW5/M2CW5

*No Window Options Available
No window options available in 14' wide doors. Hardware shown may not be included; please see your local dealer for details.

Adams P3 Series

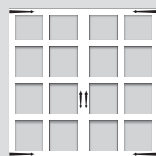

P3AS/M3AS



P3AW1/M3AW1



P3AW2/M3AW2



P3AW3/M3AW3



P3AW4/M3AW4

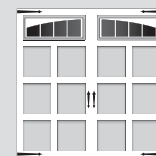

P3AW5/M3AW5

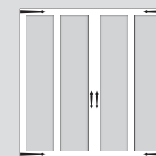

P3BS*

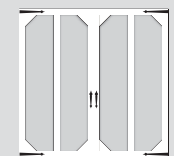

P3CS*

Jefferson P4 Series

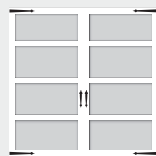

P4AS/M4AS

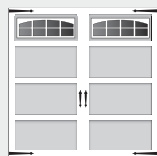

P4AW1/M4AW1



P4AW2/M4AW2

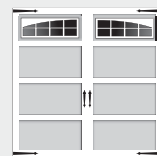

P4AW3/M4AW3

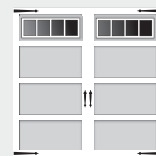

P4AW4/M4AW4

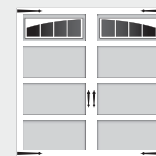

P4AW5/M4AW5

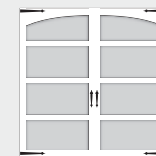

P4BS*

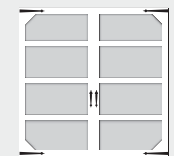

P4CS*

Lincoln P5 Series

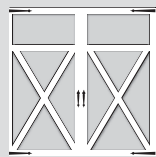

P5AS/M5AS



P5AW1/M5AW1



P5AW2/M5AW2

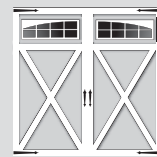

P5AW3/M5AW3

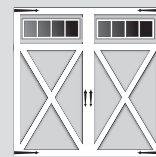

P5AW4/M5AW4

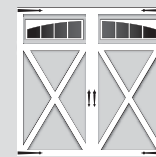

P5AW5/M5AW5

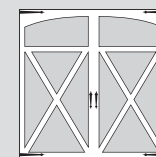

P5DS*

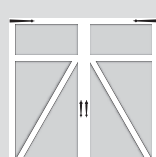

P5BS/M5BS

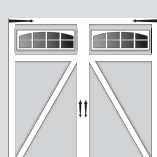

P5BW1/M5BW1

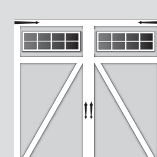

P5BW2/M5BW2

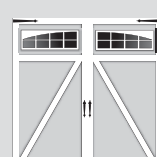

P5BW3/M5BW3

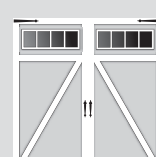

P5BW4/M5BW4

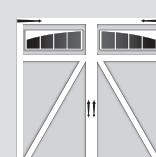

P5BW5/M5BW5

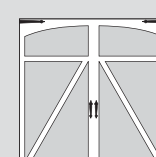

P5ES*

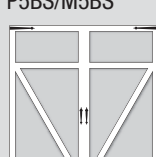

P5CS/M5CS



P5CW1/M5CW1



P5CW2/M5CW2



P5CW3/M5CW3



P5CW4/M5CW4



P5CW5/M5CW5

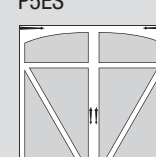

P5FS*

Hardware & Construction

Base Door Colors



Overlay Color



Presidential Premium Option

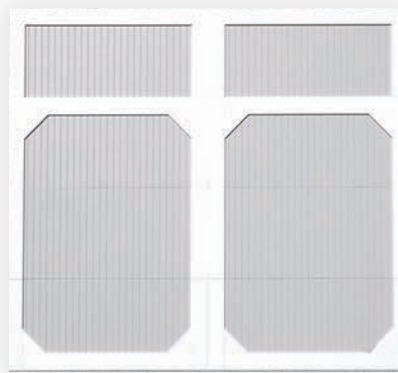

- Presidential Premium provides a completely vinyl covered surface.
- Vertical tongue and groove vinyl boards are applied over the steel surface.
- Design trim boards are applied over the vertical boards in any of the designs described in this brochure.
- Presidential Premium is available in white only.

*Above door is painted gray to highlight the vertical boards. Actual product is only available in white.

Details

- Base door and overlay material are woodgrain textured.
- 18 designs available
- Overlay color is available in white only.
- Presidential Series doors are available up to 10' in height. Windows are available in most heights; however, doors over 8' may be more aesthetically pleasing without windows. Customized sizes over 10' are available. Please consult your dealer for details.
- 5 window designs available.
- The Presidential Series base and overlays can be painted. Safe-Way specifies Sherwin-Williams® VinylSafe™ paint colors only (available in Sherwin-Williams Duration® Exterior Coating or SuperPaint® Exterior Paint). Failure to use this paint will void the product warranty.

Handles



Carriage Knocker Kit



Hammered Iron Handle



Carriage Handle



Steel Handle

Hinges



Steel Strap Hinge



Hammered Iron Hinge



Steel Heritage Hinge

Decorative Hardware Options



Iron Stud with Screw



Hammered Iron Stud



*Picture notates the color variations of a white base door and the white vinyl overlay.

*Additional decorative hardware options are available. Consult your dealer for details.

Presidential Door Construction

1. 11 ball nylon rollers provide quiet operation and long lasting durability.
2. Heavy duty galvanized 14 gauge hardware
3. Tongue and groove design provides weathertight section joints
4. Expanded polystyrene insulation provides an R-Value of 10.25.
5. Steel skins inside and out provide maximum durability.
6. Aluminum bottom retainer with vinyl weatherstrip.

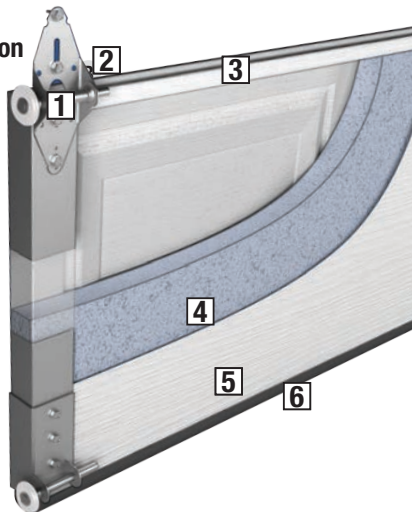

Monarch Door Construction

1. Tongue and groove enclosed with bulb type polypropylene thermal break anchored within the polyurethane core.
2. Polyurethane injected insulation provides an R-value of 17.68
3. Steel skins inside and out provide maximum durability.
4. 20 gauge pre-painted heavy steel end stiles for added strength.
5. Interior 20 gauge backer plate full height of section at all hinge points.

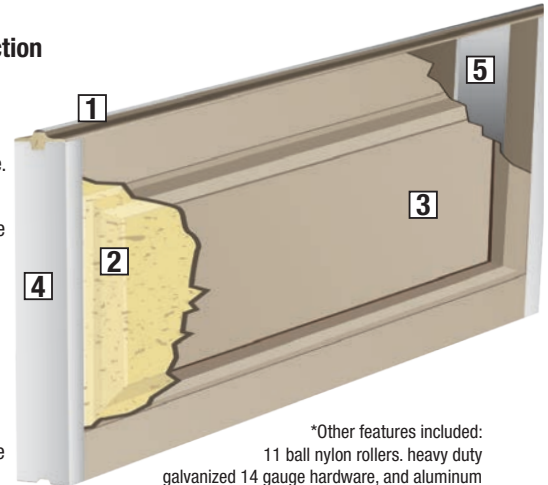

*Other features included: 11 ball nylon rollers, heavy duty galvanized 14 gauge hardware, and aluminum bottom retainer with vinyl weatherstrip.

Distributed by:



As Safe-Way Door constantly strives to improve our product, all specifications listed in this informative brochure are subject to change without notice or obligation. Printed color may vary from actual color, please check with your local dealer for color swatches.

11/2020

3814 East U.S. 30 • Warsaw, IN 46580
574-267-4861 • Fax: 574-267-2871
safewaydoor.com